

18V, 2A Synchronous Step-Down DC/DC Converter

Description

The FR9212B is a synchronous step-down DC/DC converter with fast constant on time (FCOT) mode control. The device provides 4.5V to 18V input voltage range and 2A continuous load current capability. Operation frequency depends on Input and output voltage condition. At light load condition, the FR9212B can operate at power saving mode to support high efficiency and reduce power loss.

The FR9212B fault protection includes cycle-by-cycle current limit, short circuit protection, UVLO and thermal shutdown. The soft-start function prevents inrush current at turn-on. The FR9212B use fast constant on time control that provides fast transient response, the noise immunity and all kinds of very low ESR output capacitor for ensuring performance stabilization.

Features

- Low $R_{DS(ON)}$ Integrated Power MOSFET (120mΩ/80mΩ)
- Wide Input Voltage Range: 4.5V to 18V
- Output Voltage Range: 0.6V to 8V
- 2A Output Current
- FCOT Mode Enables Fast Transient Response
- Pseudo 600kHz Frequency
- Input Under Voltage Lockout
- Internal 1ms Soft-Start
- Cycle-by-Cycle Current Limit
- Hiccup Short Circuit Protection
- Over Temperature Protection with Auto Recovery
- SOT-23-6L Package

Applications

- STB (Set-Top-Box)
- LCD Display, TV
- Distributed Power System
- Networking, XDSL Modem

Pin Assignments

S6B Package: SOT-23-6L

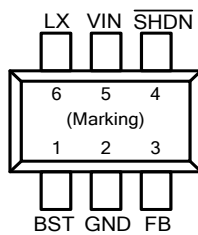

Figure 1. Pin Assignments of FR9212B

Ordering Information

FR9212B Package Type
S6B: SOT-23-6L

SOT-23-6L Marking

Part Number	Product Code
FR9212BS6B	GS1

Typical Application Circuit

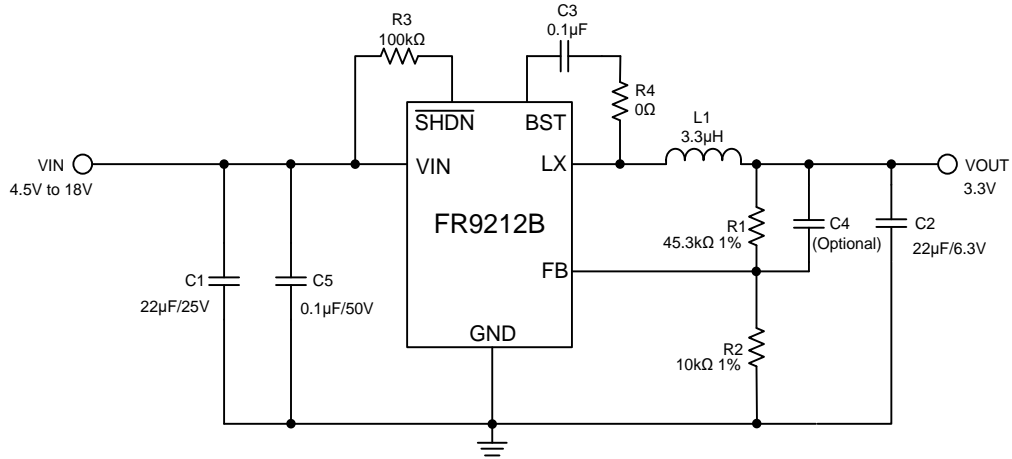

Figure 2. FR9212B Application Circuit

$V_{IN}=12V$, the recommended BOM list is as below.

V_{out}	C1	R1	R2	L1	C4	C2
1V	22µF MLCC	6.65kΩ	10kΩ	1.5µH	NC~100pF	22µF MLCC
1.05V	22µF MLCC	7.5kΩ	10kΩ	1.5µH	NC~100pF	22µF MLCC
1.2V	22µF MLCC	10kΩ	10kΩ	1.5µH	NC~100pF	22µF MLCC
1.8V	22µF MLCC	20kΩ	10kΩ	1.5µH	NC~100pF	22µF MLCC
2.5V	22µF MLCC	31.6kΩ	10kΩ	3.3µH	NC~100pF	22µF MLCC
3.3V	22µF MLCC	45.3kΩ	10kΩ	3.3µH	NC~100pF	22µF MLCC
5V	22µF MLCC	73.2kΩ	10kΩ	4.7µH	NC~100pF	22µF MLCC

Table 1. FR9212B Recommended Component Value

Functional Pin Description

Pin Name	Pin No.	Pin Function
BST	1	High side gate drive boost pin. A capacitor rating between 0.1uF~1uF must be connected from this pin to LX. It can boost the gate drive to fully turn on the internal high side NMOS.
GND	2	Ground pin.
FB	3	Voltage feedback input pin. Connect FB and VOUT with a resistive voltage divider. This IC senses feedback voltage via FB and regulates it at 0.6V.
$\overline{\text{SHDN}}$	4	Enable input pin. Pull high to turn on IC, and pull low to turn off IC. Connect VIN with a 100kΩ resistor for self-startup.
VIN	5	Power supply input pin. Placed input capacitors as close as possible from VIN to GND to avoid noise influence.
LX	6	Power switching node. Connect an external inductor to this switching node.

Block Diagram

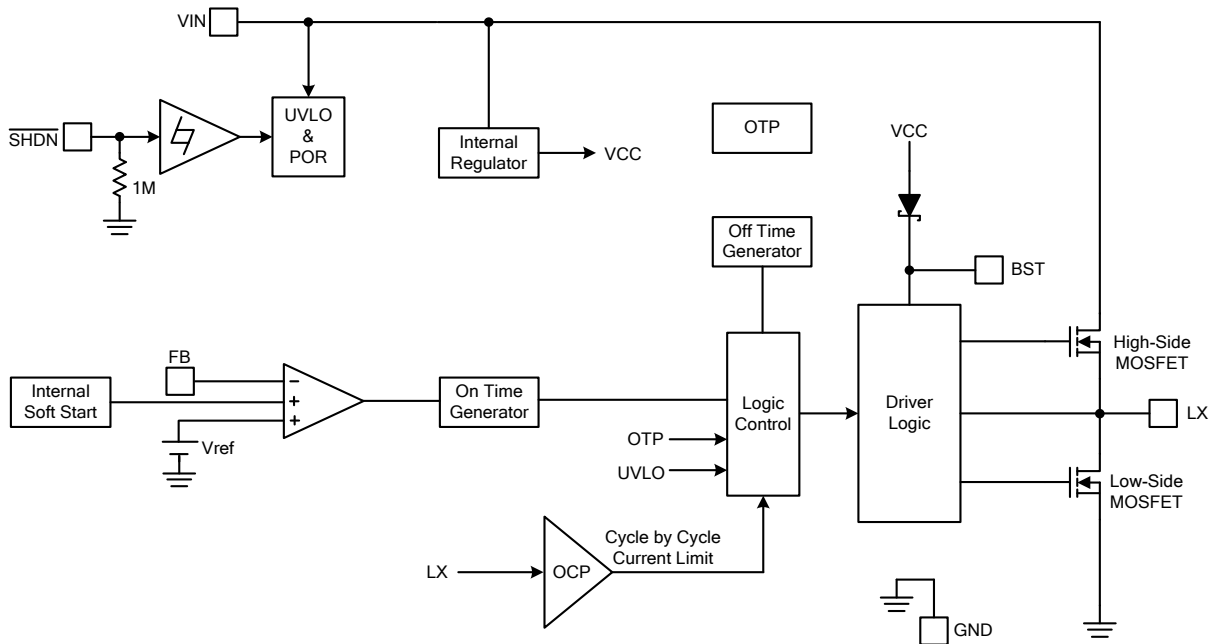

Figure 3. Block Diagram of FR9212B

Absolute Maximum Ratings ^(Note 1)

- Supply Voltage V_{IN} ----- -0.3V to +20V
- Enable Voltage $V_{\overline{SHDN}}$ ----- -0.3V to +20V
- LX Voltage V_{LX} ----- -0.3V to ($V_{IN} + 0.3V$)
- Dynamic LX Voltage in 15ns Duration ----- -5V to $V_{IN} + 5V$
- BST Pin Voltage V_{BST} ----- -0.3V to $V_{LX} + 6.5V$
- All Other Pins Voltage ----- -0.3V to +6V
- Maximum Junction Temperature (T_J) ----- +150°C
- Storage Temperature (T_S) ----- -65°C to +150°C
- Lead Temperature (Soldering, 10sec.) ----- +260°C
- SOT-23-6L Package Thermal Resistance for JEDEC-51-7
 - θ_{JA} ^(Note 2) ----- 250°C/W
 - θ_{JC} ^(Note 2) ----- 110°C/W
- SOT-23-6L Package Thermal Resistance for EVB
 - θ_{JA} ^(Note 3) ----- 90.98°C/W
 - θ_{JC} ^(Note 3) ----- 64.44°C/W

Note 1: Stresses beyond this listed under "Absolute Maximum Ratings" may cause permanent damage to the device.

Note 2: θ_{JA} is measured at 25°C ambient with the component mounted on a high effective thermal conductivity 4-layer board of JEDEC-51-7. The thermal resistance greatly varies with layout, copper thickness, number of layers and PCB size.

Note 3: EVB (θ_{JA}) and (θ_{JC}) are measured at 25°C ambient with the component mounted on a high effective thermal conductivity fitipower demo board. The thermal resistance/parameter values greatly varies with layout, copper thickness, number of layout layers, PCB size and test environmental conditions.

Recommended Operating Conditions

- Supply Voltage V_{IN} ----- +4.5V to +18V
- Operating Ambient Temperature Range ----- -40°C to +85°C
- Operating Junction Temperature Range ----- -40°C to +125°C

Electrical Characteristics

($V_{IN}=12V$, $T_A=25^{\circ}C$, unless otherwise specified.)

Parameter	Symbol	Conditions	Min	Typ	Max	Unit
V_{IN} Quiescent Current	I_{DDQ}	$V_{\overline{SHDN}}=2V$, $V_{FB}=1V$		0.27	0.35	mA
V_{IN} Shutdown Supply Current	I_{SD}	$V_{\overline{SHDN}}=0V$		12	15	μA
Feedback Voltage	V_{FB}	$4.5V \leq V_{IN} \leq 18V$	0.588	0.6	0.612	V
Feedback Input Current	I_{FB}	$V_{FB}=1V$		0.01	0.1	μA
High-Side MOSFET $R_{DS(ON)}$	$R_{DS(ON)}$			120		m Ω
Low-Side MOSFET $R_{DS(ON)}$	$R_{DS(ON)}$			80		m Ω
Valley Current Limit (Note 4)	I_{LIMIT}			2.9		A
Minimum On Time	T_{ON}			60		ns
Minimum Off Time	$T_{OFF(MIN)}$	$V_{FB}=0.5V$		200		ns
Input Supply Voltage UVLO Threshold	$V_{UVLO(Vth)}$	V_{IN} Rising		4		V
UVLO Threshold Hysteresis	$V_{UVLO(HYS)}$			0.4		V
Internal Soft-Start Period (Note 4)	T_{SS}			1		ms
\overline{SHDN} Input Low Voltage	$V_{\overline{SHDN}(L)}$				0.8	V
\overline{SHDN} Input High Voltage	$V_{\overline{SHDN}(H)}$		1.6			V
\overline{SHDN} Input Current	$I_{\overline{SHDN}}$	$V_{\overline{SHDN}}=2V$		2		μA
Thermal Shutdown Threshold (Note 4)	T_{SD}			160		$^{\circ}C$
Thermal Shutdown Hysteresis (Note 4)	T_{HYS}			30		$^{\circ}C$

Note 4: Not production tested.

Typical Performance Curves

$V_{OUT}=1V$

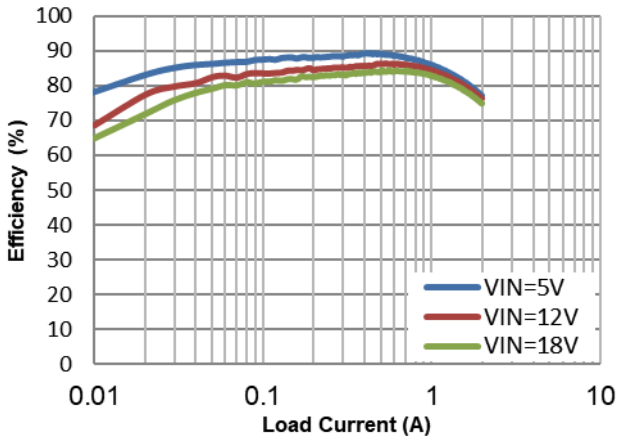

Figure 4. Efficiency vs. Load Current

$V_{OUT}=3.3V$

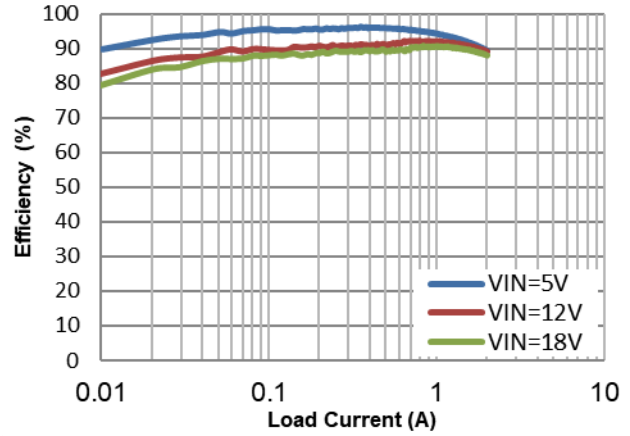

Figure 5. Efficiency vs. Load Current

$V_{OUT}=5V$

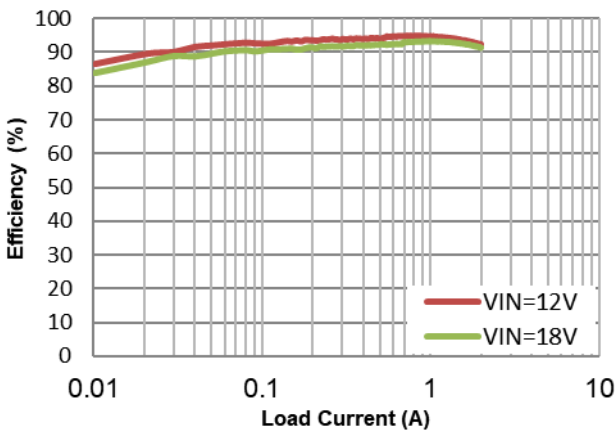

Figure 6. Efficiency vs. Load Current

$V_{SHDN}=2V, V_{FB}=1V$

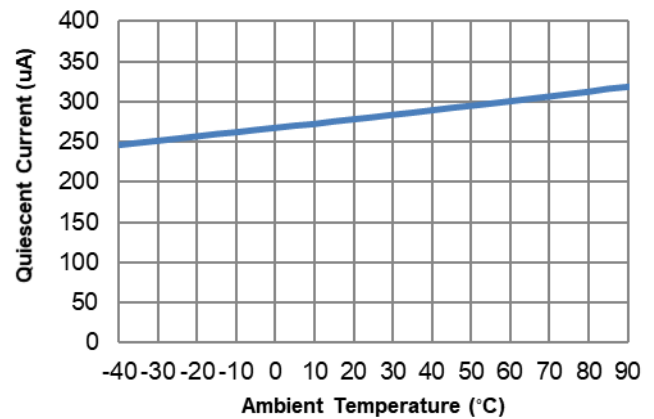

Figure 7. Quiescent Current vs. Ambient Temperature

$V_{IN}=12V, V_{OUT}=3.3V, I_{OUT}=0.4A \text{ to } 2A$

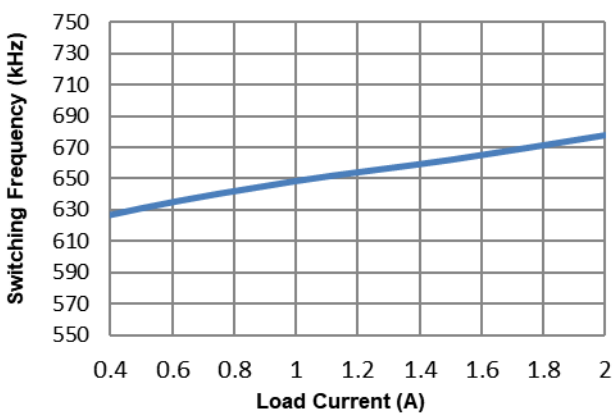

Figure 8. Switching Frequency vs. Load Current

$V_{IN}=12V$

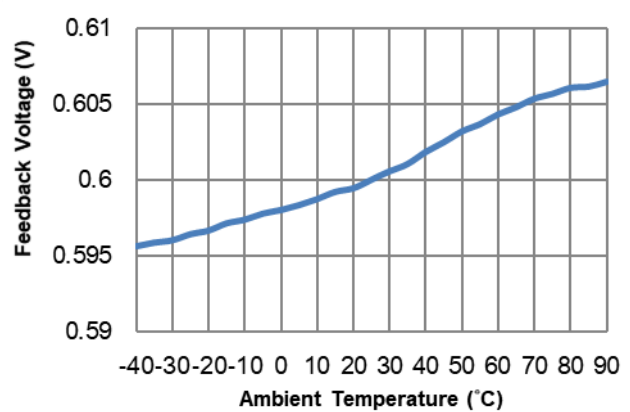
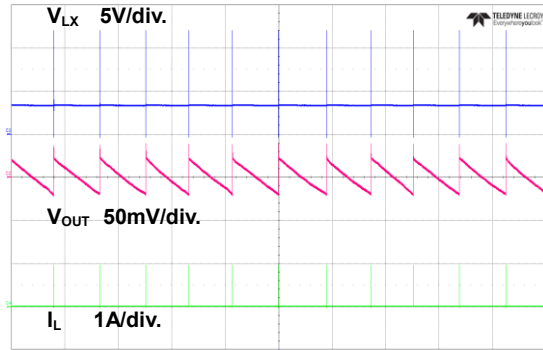

Figure 9. Feedback Voltage vs. Ambient Temperature

Typical Performance Curves (Continued)

$V_{IN}=12V$, $V_{OUT}=3.3V$, $C1=22\mu F$, $C2=22\mu F$, $L1=3.3\mu H$, $T_A=+25^{\circ}C$, unless otherwise noted.

$I_{OUT}=0A$



2 μs /div.

Figure 10. Steady State Waveform

$I_{OUT}=2A$

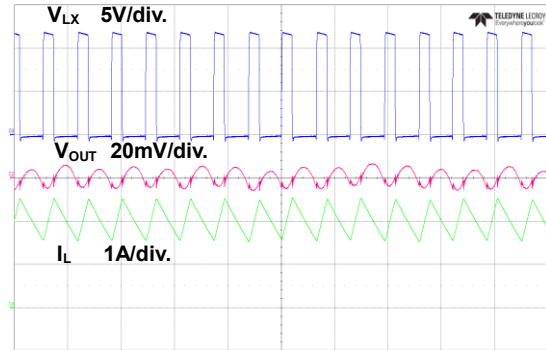

2 μs /div.

Figure 11. Steady State Waveform

$I_{OUT}=0A$

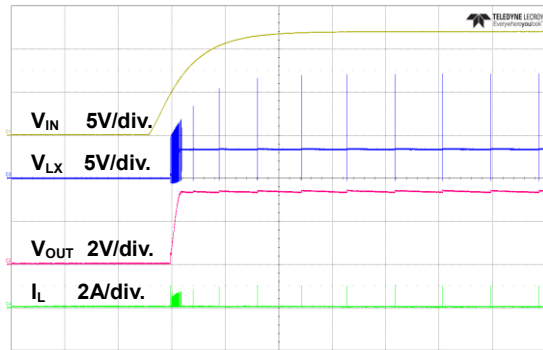

5ms/div.

Figure 12. Startup Through Power Supply Waveform

$I_{OUT}=2A$

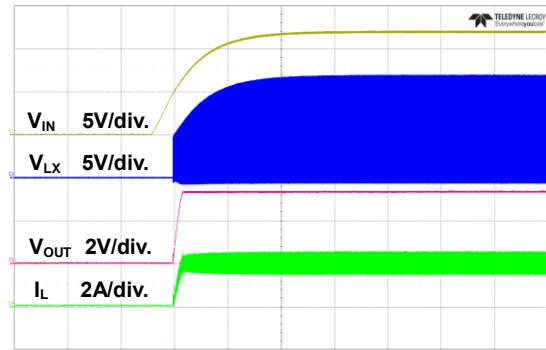

5ms/div.

Figure 13. Startup Through Power Supply Waveform

$I_{OUT}=0A$

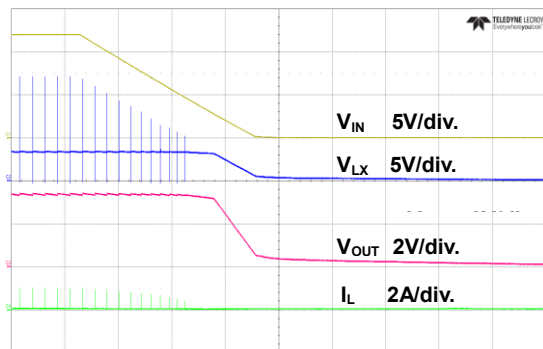

20ms/div.

Figure 14. Shutdown Through Power Supply Waveform

$I_{OUT}=2A$

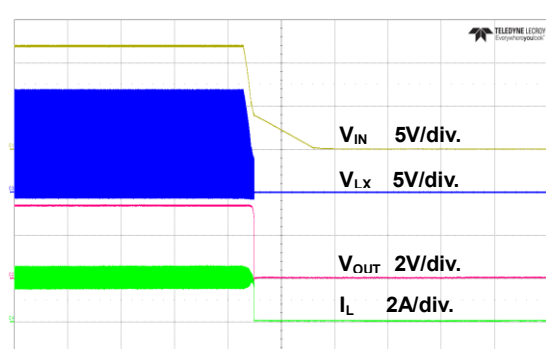

20ms/div.

Figure 15. Shutdown Through Power Supply Waveform

Typical Performance Curves (Continued)

$V_{IN}=12V$, $V_{OUT}=3.3V$, $C1=22\mu F$, $C2=22\mu F$, $L1=3.3\mu H$, $T_A=+25^{\circ}C$, unless otherwise noted.

$I_{OUT}=0A$

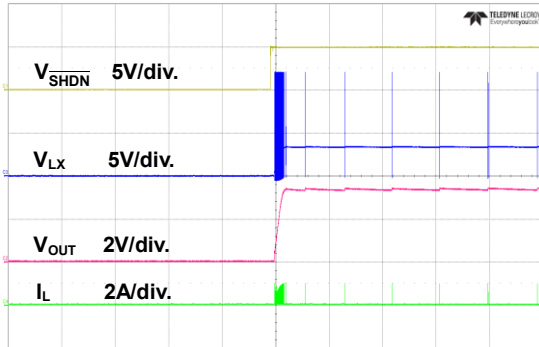

5ms/div.

Figure 16. Startup Through \overline{SHDN} Waveform

$I_{OUT}=2A$

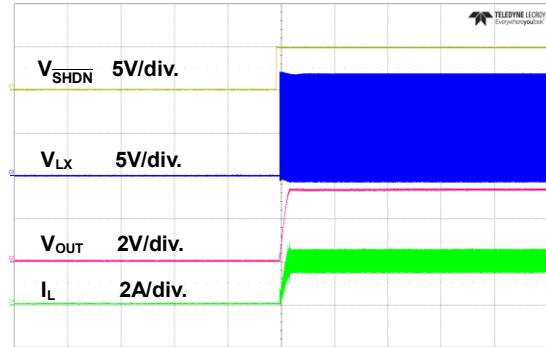

5ms/div.

Figure 17. Startup Through \overline{SHDN} Waveform

$I_{OUT}=0A$

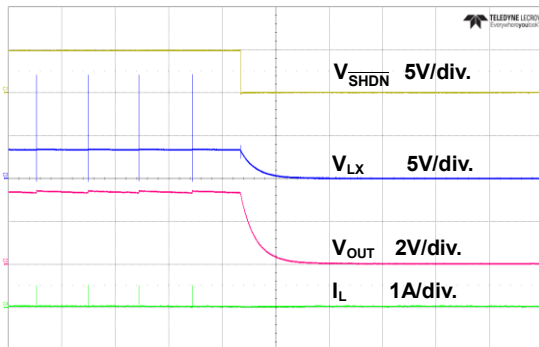

5ms/div.

Figure 18. Shutdown Through \overline{SHDN} Waveform

$I_{OUT}=2A$

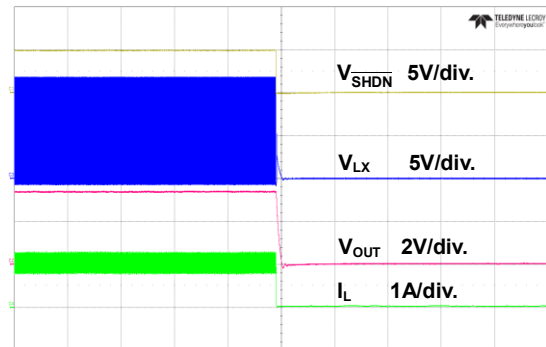

200µs/div.

Figure 19. Shutdown Through \overline{SHDN} Waveform

$I_{OUT}=0A$ to $2A$

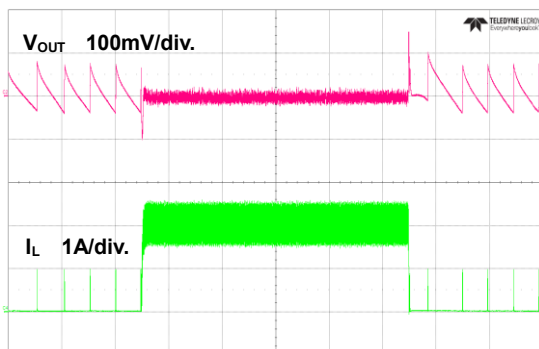

200µs/div.

Figure 20. Load Transient Waveform

Function Description

The FR9212B is a synchronous step-down DC/DC converter with fast constant on time (FCOT) mode control. It has integrated high-side (120mΩ,typ) and low-side (80mΩ,typ) power switches, and provides 2A continuous load current. It regulates input voltage from 4.5V to 18V, and down to an output voltage as low as 0.6V. Using FCOT control scheme provides fast transient response, which can minimize the component size without additional external compensation network.

Enable

The FR9212B $\overline{\text{SHDN}}$ pin provides digital control to turn on/turn off the regulator. When the voltage of $\overline{\text{SHDN}}$ exceeds the threshold voltage, the regulator starts the soft start function. If the $\overline{\text{SHDN}}$ pin voltage is below than the shutdown threshold voltage, the regulator will turn into the shutdown mode and the shutdown current will be smaller than 1μA. For auto start-up operation, connect $\overline{\text{SHDN}}$ to VIN through a 100kΩ resistor.

Soft Start

The FR9212B employs internal soft start function to reduce input inrush current during start up. The typical value of internal soft start time is 1ms.

Input Under Voltage Lockout

When the FR9212B is power on, the internal circuits are held inactive until V_{IN} voltage exceeds the input UVLO threshold voltage. And the regulator will be disabled when V_{IN} is below the input UVLO threshold voltage. The hysteric of the UVLO comparator is 400mV (typ).

Over Current Protection

The FR9212B over current protection function is implemented using cycle-by-cycle current limit architecture. The inductor current is monitored by Low-side MOSFET. When the load current increases, the inductor current also increases. When the valley inductor current reaches the current limit threshold, the output voltage starts to drop. When the over current condition is removed, the output voltage returns to the regulated value.

Short Circuit Protection

The FR9212B provides short circuit protection function to prevent the device damage from short condition. When the short condition occurs and the feedback voltage drops lower than 55% of V_{FB} , the oscillator frequency will be reduced naturally and hiccup mode will be triggered to prevent the inductor current increasing beyond the current limit. Once the short condition is removed, the frequency will return to normal.

Over Temperature Protection

The FR9212B incorporates an over temperature protection circuit to protect itself from overheating. When the junction temperature exceeds the thermal shutdown threshold temperature, the regulator will be shutdown. And the hysteric of the over temperature protection is 30°C (typ).

Application Information

Output Voltage Setting

The output voltage V_{OUT} is set using a resistive divider from the output to FB.

The FB pin regulated voltage of FR9212B is 0.6V. Thus the output voltage equation is:

$$V_{OUT} = 0.6V \times \left(1 + \frac{R1}{R2} \right)$$

Table 2 lists recommended values of R1 and R2 for FR9212B most used output voltage.

Table 2 Recommended Resistance Values

V_{OUT}	R1	R2
5V	73.2k Ω	10k Ω
3.3V	45.3k Ω	10k Ω
2.5V	31.6k Ω	10k Ω
1.8V	20k Ω	10k Ω
1.2V	10k Ω	10k Ω
1.05V	7.5k Ω	10k Ω
1V	6.65k Ω	10k Ω

Place resistors R1 and R2 close to FB pin to prevent stray pickup.

Input Capacitor Selection

The use of the input capacitor is filtering the input voltage ripple and the MOSFETS switching spike voltage. Because the input current to the step-down converter is discontinuous, the input capacitor is required to supply the current to the converter to keep the DC input voltage. The capacitor voltage rating should be 1.25 to 1.5 times greater than the maximum input voltage. The input capacitor ripple current RMS value is calculated as:

$$I_{CIN(RMS)} = I_{OUT} \times \sqrt{D \times (1-D)}$$

$$D = \frac{V_{OUT}}{V_{IN}}$$

Where D is the duty cycle of the power MOSFET. This function reaches the maximum value at $D=0.5$ and the equivalent RMS current is equal to $I_{OUT}/2$. The following diagram is the graphical representation of above equation.

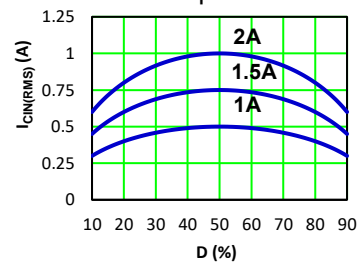

A low ESR capacitor is required to keep the noise minimum. Ceramic capacitors are better, but tantalum or low ESR electrolytic capacitors may also suffice. When using tantalum or electrolytic capacitors, a 0.1 μ F ceramic capacitor should be placed as close to the IC as possible.

Application Information (Continued)

Output Capacitor Selection

The output capacitor is used to keep the DC output voltage and supply the load transient current. When operating in constant current mode, the output ripple is determined by four components:

$$V_{\text{RIPPLE}}(t) = V_{\text{RIPPLE(C)}}(t) + V_{\text{RIPPLE(ESR)}}(t) + V_{\text{RIPPLE(ESL)}}(t) + V_{\text{NOISE}}(t)$$

The following figures show the form of the ripple contributions.

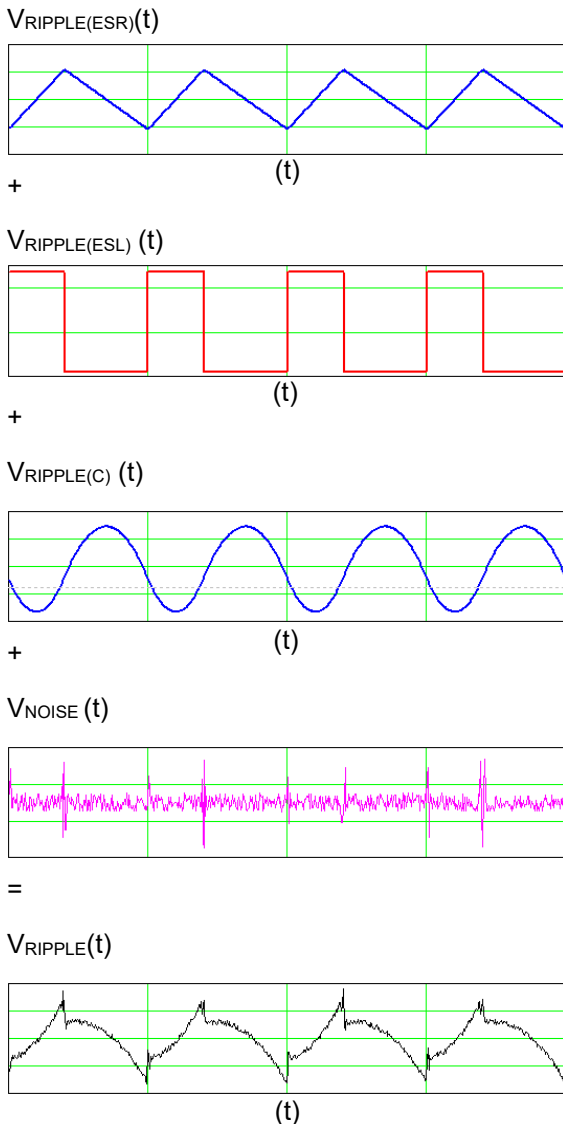

$$V_{\text{RIPPLE(ESR)}} = \frac{V_{\text{OUT}}}{F_{\text{OSC}} \times L} \times \left(1 - \frac{V_{\text{OUT}}}{V_{\text{IN}}}\right) \times \text{ESR}$$

$$V_{\text{RIPPLE(ESL)}} = \frac{\text{ESL}}{L} \times V_{\text{IN}}$$

$$V_{\text{RIPPLE(C)}} = \frac{V_{\text{OUT}}}{8 \times F_{\text{OSC}}^2 \times L \times C_{\text{OUT}}} \times \left(1 - \frac{V_{\text{OUT}}}{V_{\text{IN}}}\right)$$

Where F_{OSC} is the switching frequency, L is the inductance value, V_{IN} is the input voltage, ESR is the equivalent series resistance value of the output capacitor, ESL is the equivalent series inductance value of the output capacitor and the C_{OUT} is the output capacitor.

Low ESR capacitors are preferred to use. Ceramic, tantalum or low ESR electrolytic capacitors can be used depending on the output ripple requirement. When using the ceramic capacitors, the ESL component is usually negligible.

It is important to use the proper method to eliminate high frequency noise when measuring the output ripple. The figure shows how to locate the probe across the capacitor when measuring output ripple. Removing the scope probe plastic jacket in order to expose the ground at the tip of the probe. It gives a very short connection from the probe ground to the capacitor and eliminating noise.

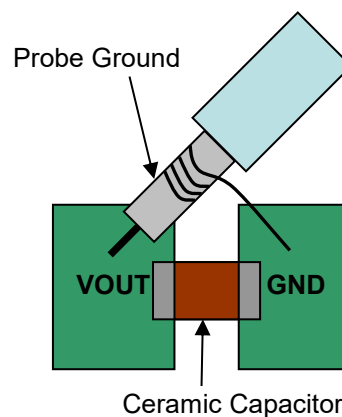

Application Information (Continued)

Inductor Selection

The output inductor is used for storing energy and filtering output ripple current. But the trade-off condition often happens between maximum energy storage and the physical size of the inductor. The first consideration for selecting the output inductor is to make sure that the inductance is large enough to keep the converter in the continuous current mode.

That will lower ripple current and result in lower output ripple voltage. The ΔI_L is inductor peak-to-peak ripple current:

$$\Delta I_L = \frac{V_{OUT}}{F_{OSC} \times L} \times \left(1 - \frac{V_{OUT}}{V_{IN}}\right)$$

A good compromise value between size and efficiency is to set the peak-to-peak inductor ripple current ΔI_L equal to 30% of the maximum load current. But setting the peak-to-peak inductor ripple current ΔI_L between 20%~50% of the maximum load current is also acceptable. Then the inductance can be calculated with the following equation:

$$\Delta I_L = 0.3 \times I_{OUT(MAX)}$$

$$L = \frac{(V_{IN} - V_{OUT}) \times V_{OUT}}{V_{IN} \times F_{OSC} \times \Delta I_L}$$

The inductor saturation current should be selected larger than the current limit of FR9212B.

External Diode Selection

For 5V input applications, it is recommended to add an external boost diode. This helps improving the efficiency. The boost diode can be a low cost one such as 1N4148.

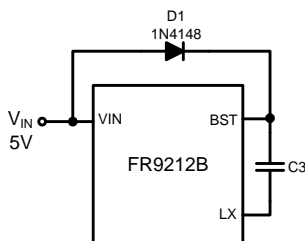

Outline Information

SOT-23-6L Package (Unit: mm)

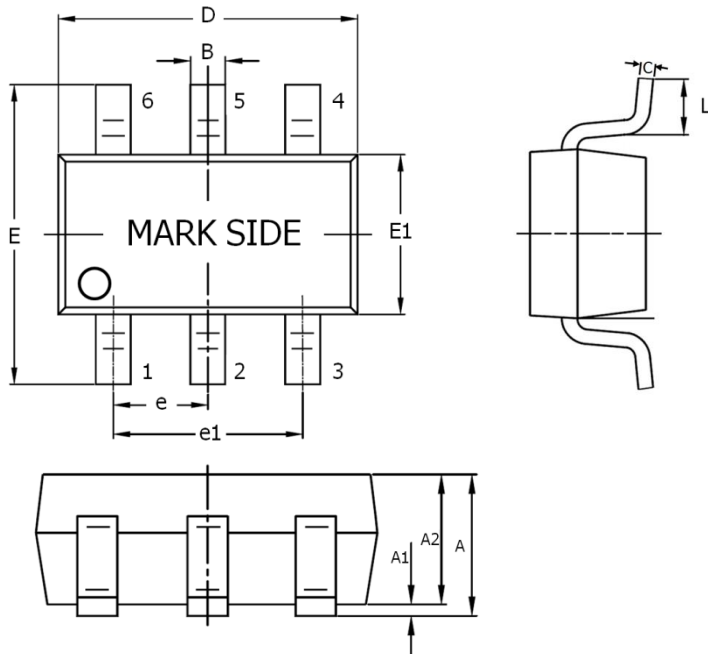

SYMBOLS UNIT	DIMENSION IN MILLIMETER	
	MIN	MAX
A	0.90	1.30
A1	0.00	0.15
A2	0.90	1.15
B	0.28	0.50
D	2.80	3.00
E	2.60	3.00
E1	1.50	1.70
e	0.90	1.00
e1	1.80	2.00
C	0.08	0.20
L	0.30	0.60

Note 5: Body dimensions do not include mold flash or protrusion. Mold flash and protrusion shall not exceed 0.3mm.
 Note 6: Reference JEDEC MO-178.

Carrier Dimensions

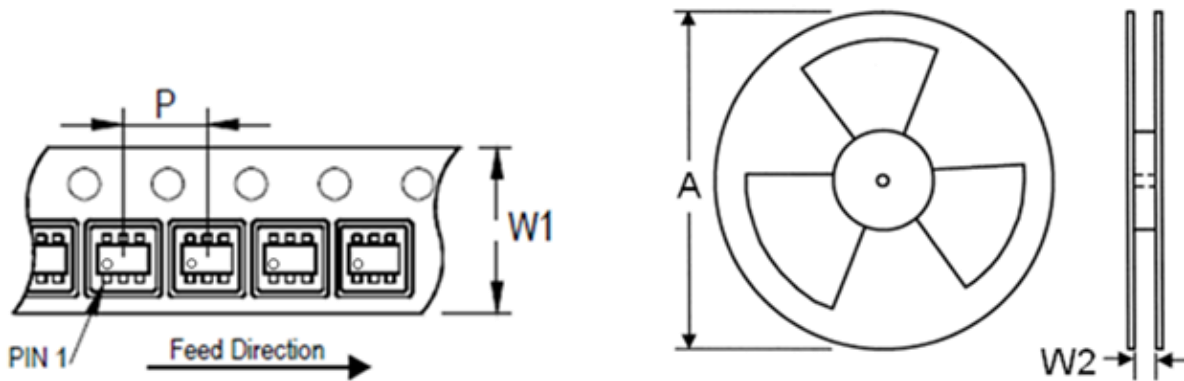

Tape Size (W1) mm	Pocket Pitch (P) mm	Reel Size (A)		Reel Width (W2) mm	Empty Cavity Length mm	Units per Reel
		in	mm			
8	4	7	180	8.4	300~1000	3,000

Life Support Policy

Fitipower's products are not authorized for use as critical components in life support devices or other medical systems.